



Alfa-MOS Technology Corp.
闡能科技股份有限公司

Company Profile



Alfa-MOS Technology Corp.

Jan. 2018



- **Alfa-MOS Technology Corp.** is established in 2010, Taipei, Taiwan. Company is near to **Taipei NanKang Sofeware Park (NKSP)**.
- **Alfa-MOS Technology Corp.** specializes intellectual properties in the development of Advance Power MOSFET & Power Management ICs.
- All of product in **Alfa-MOS Technology Corp.**, the is applied in wide electronic field, including portable electronic equipment, PC, Notebook ...etc.
- Specially, the LED Lighting & E-bike, **Alfa-MOS Technology Corp.** do the effort to support the high voltage& Ultra-Low RDS(on) Power MOSFET.
- To offer the Halogen-Free and Excellent property products, **Alfa-MOS Technology Corp.** contributes to “**Green Product**”, the product are qualified by **SGS** and meets **ROHS** specifications.





Alfa-MOS Technology Corp.
闡能科技股份有限公司

Headquarter



2F., No.80, Sec. 1, Cheng Kung Road, Nan Kang Dist., Taipei City 115, Taiwan
115台北市南港區成功路一段80號2樓 **TEL.:+886-2-2651-3928**

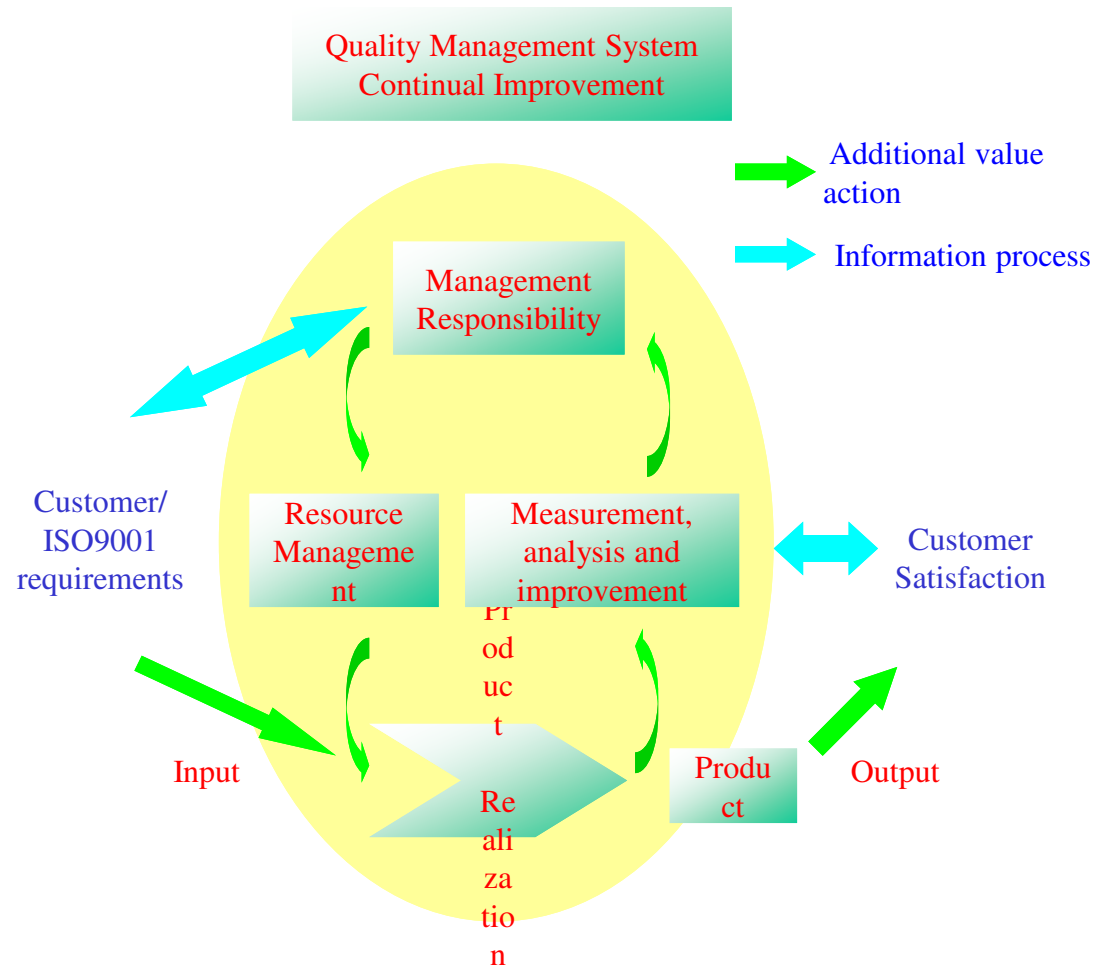

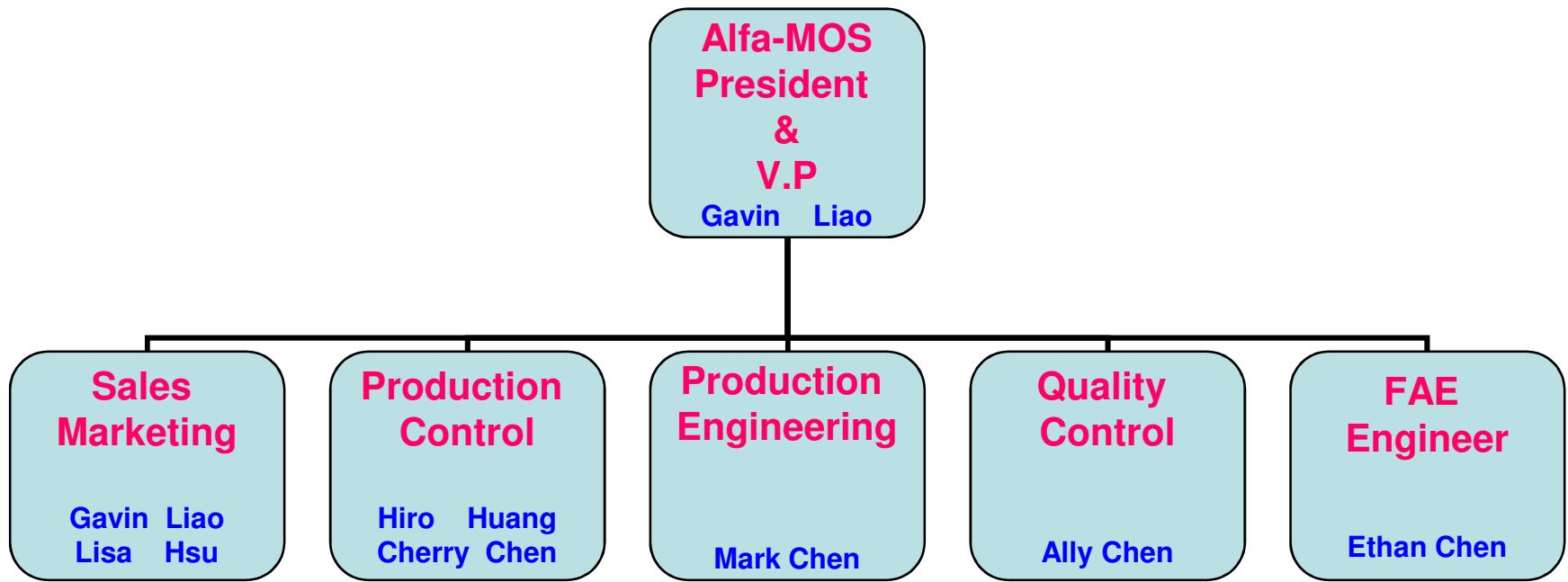



ROHS Specification

Cadmium	< 100 ppm
Hg	< 1000 ppm
Lead (Pb)*	< 1000 ppm
Hexavalent Chromium (Cr6+)	< 1000 ppm
Poly Brominated Biphenyls (PBB)	< 1000 ppm
Poly Brominated Diphenyl Ethers (PBDE)	< 1000 ppm

Green Specification

Bromine	< 900 ppm
Chlorine	< 900 ppm
Total Bromine and Chlorine	1500 ppm max
Antimony	< 900 ppm





 **Wafer Foundry**

- MOSEL Vitelic Inc.
- Episil Technologies Inc.
- Lite-On Semiconductor Corp.
- Vanguard International Semiconductor Corporation

 **Wafer Testing**

- Micro Silicon Elecs. Corporation
- Phoenix Silicon International Corporation

 **Assembly & FT**

- Jiangsu Changjiang Electronics Technology Co. Ltd.
- Fujiter Semiconductor Co.,LTD
- Shanghai SIMAT Microelectronics Technology Co.LTD
- Great Team Backend Foundry (Dongguan), ltd.



Factory	Website
Mosel Vitelic Inc.(台灣茂矽電子股份有限公司)	http://www.mosel.com.tw/
Lite-On Semiconductor Corp.(敦南科技股份有限公司)	http://www.liteon-semi.com/
Vanguard International Semiconductor Corporation (世界先進積體電路股份有限公司)	http://www.vis.com.tw/
Episil Technologies Inc.(漢磊科技股份有限公司)	http://www.episil.com/
Micro Silicon Elecs. Corp.(台灣微矽電子股份有限公司)	http://www.msec.com.tw/
Phoenix Silicon International Corp.(昇陽國際半導體股份有限公司)	http://www.psi.com.tw/
Jiangsu Changjiang Electronics Technology Co. LTD.(江蘇長電科技股份有限公司)	http://www.cj-elec.com/
Fujiter Semiconductor Co.,LTD(富吉特半導體股份有限公司)	http://www.fujiter.com.tw/
Shanghai SIMAT Microelectronics Technology Co.LTD(上海芯哲微電子科技有限公司)	http://www.simat-sh.com/
Great Team Backend Foundry (Dongguan), ltd.(杰群電子科技(東莞)有限公司)	http://www.gtbf-ltd.com/



- **ISO Certified Supply Chains**

EPI Wafer Manufacturer : ISO 9001 Certified ISO 14001 Certified QS 9000 Certified Health and Safety Certified	Wafer Foundry : ISO 9001 Certified TS16949 Certified ISO 14001 Certified ISO Guide 25 Certified
Assembly House : ISO 9002 Certified TS 16949 Certified ISO 14001 Certified QS 9000 Certified	Alfa-MOS : ISO 9001 Certified



Product Family

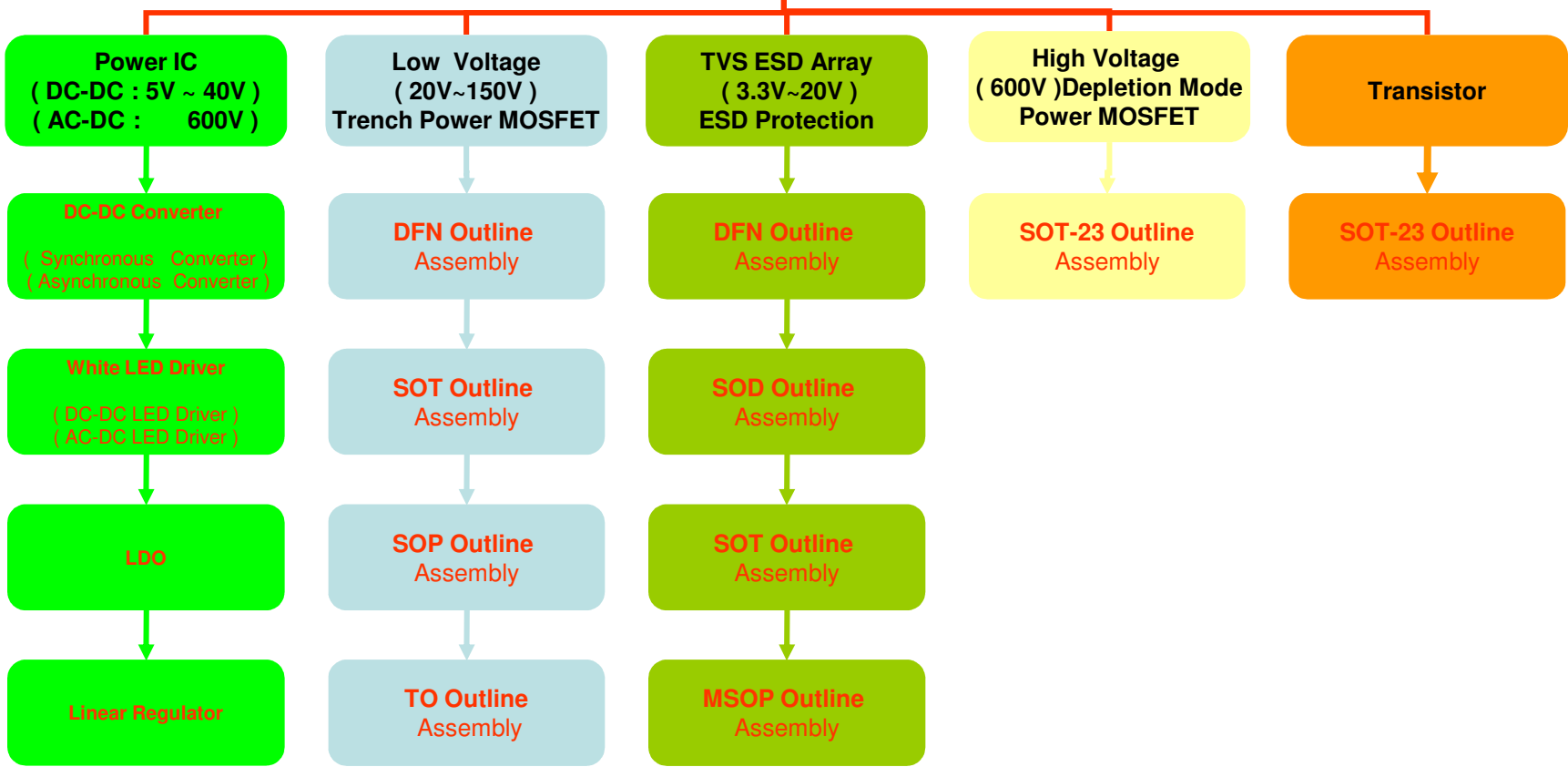

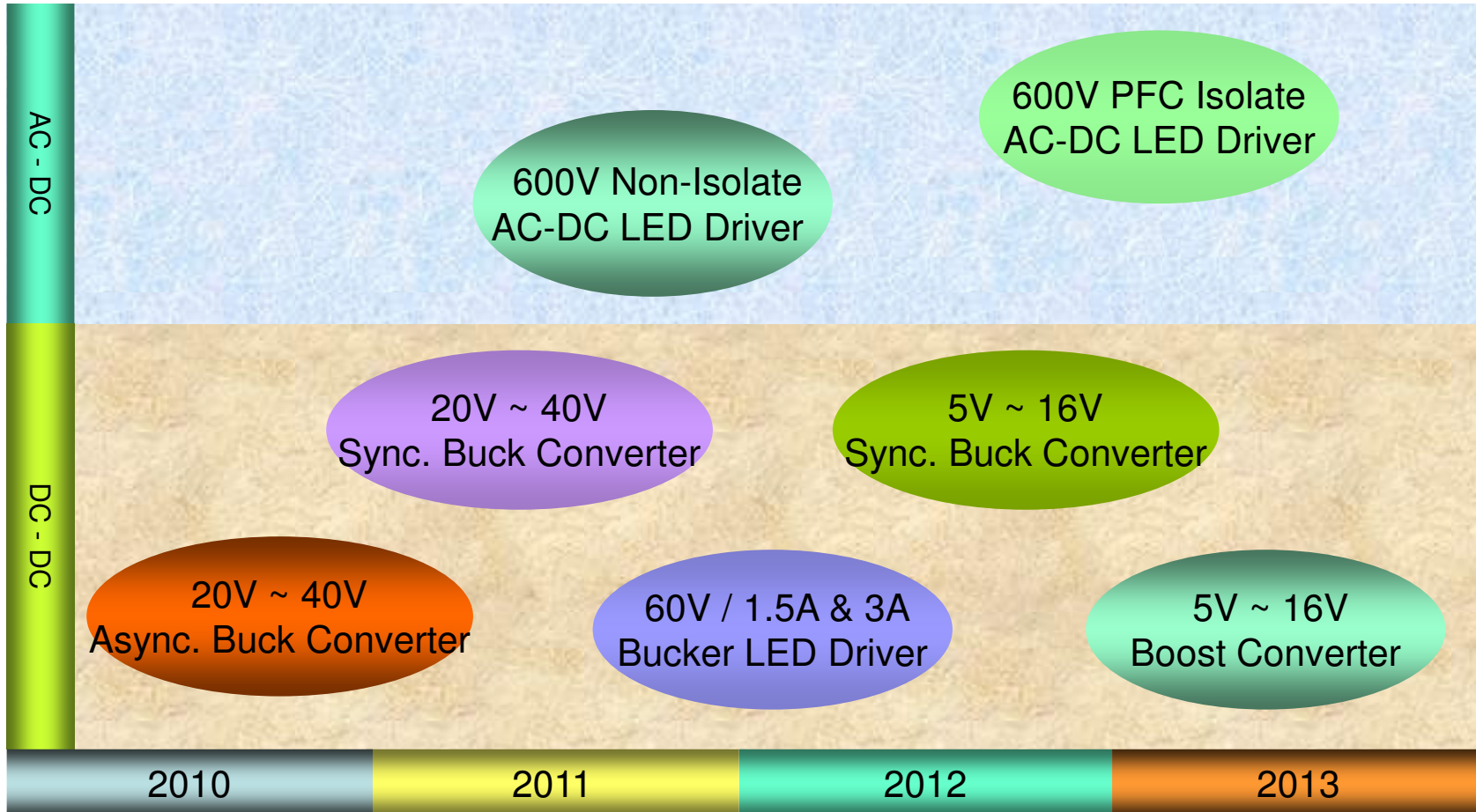

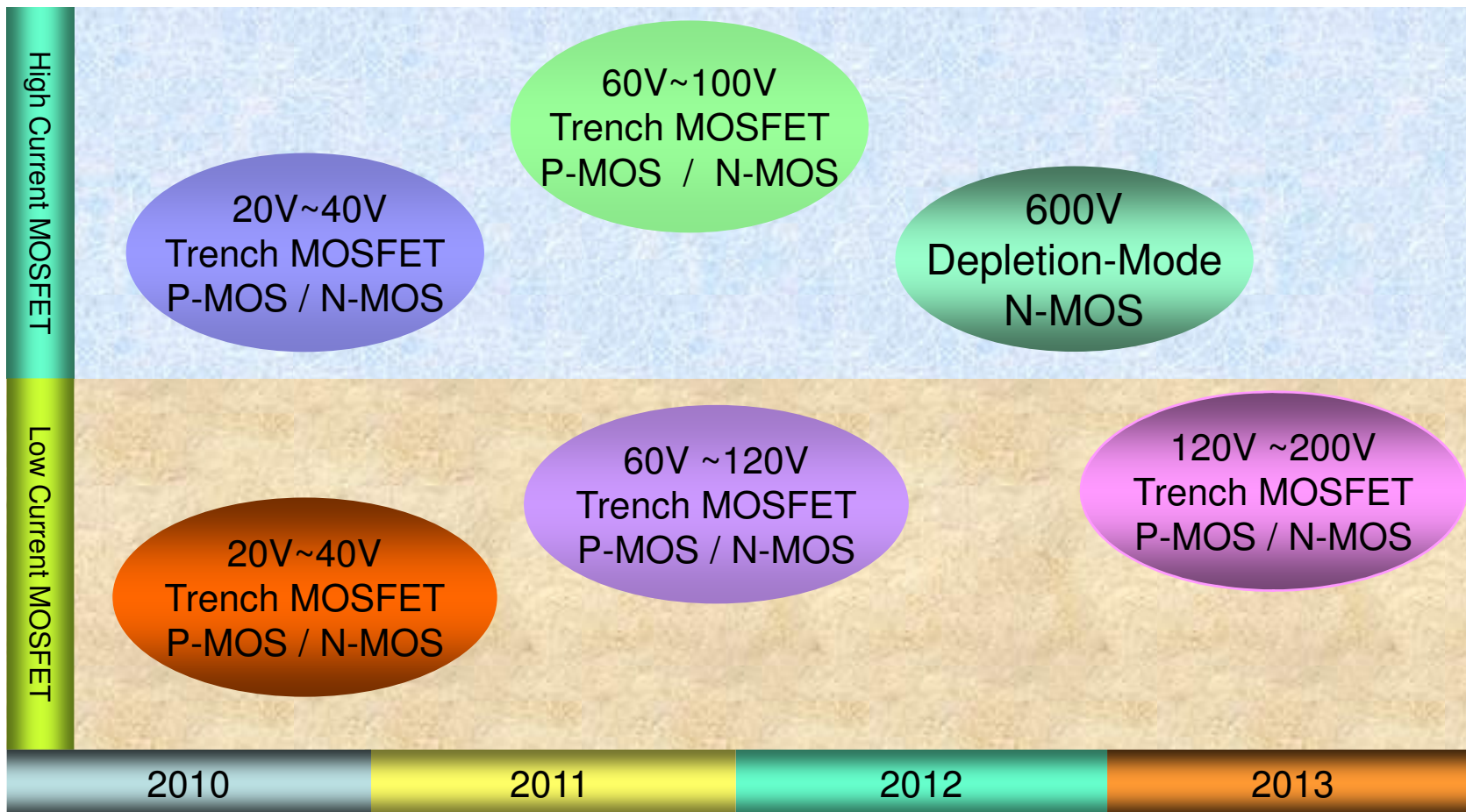

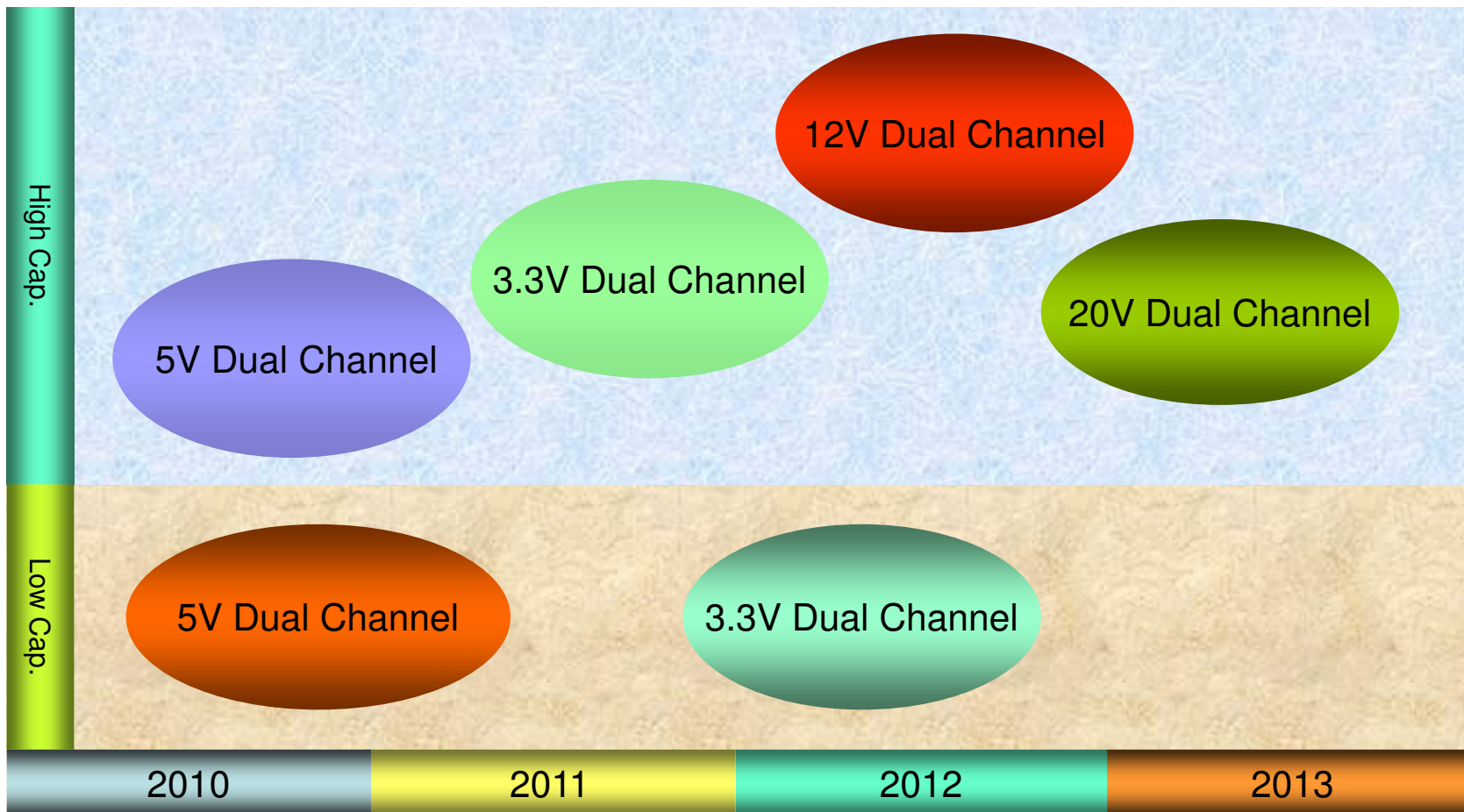



Alfa-MOS Technology Corp.
闡能科技股份有限公司

Marketing





Alfa-MOS Technology Corp.
闡能科技股份有限公司

Power Management IC Application



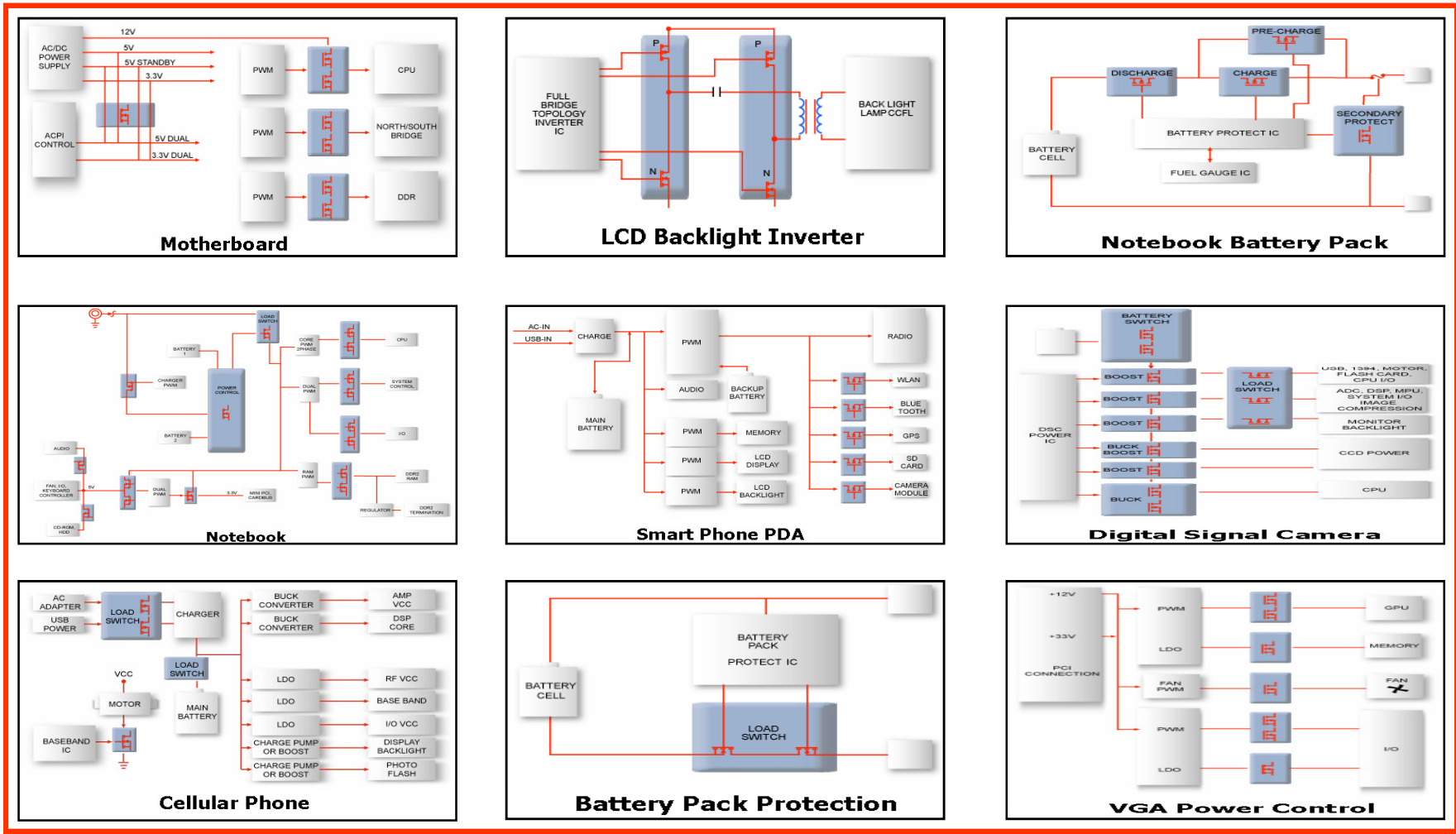

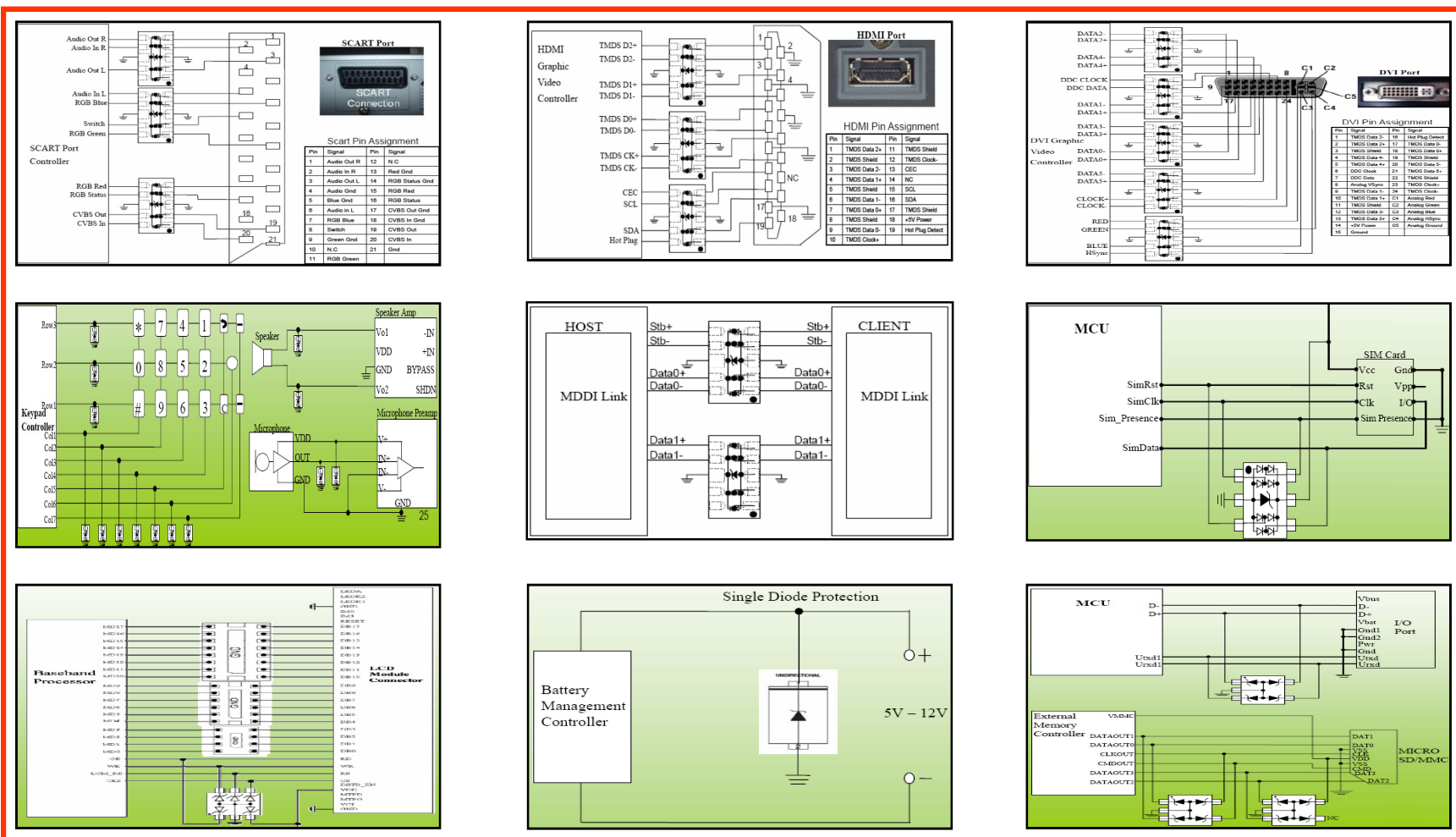



Alfa-MOS Technology Corp.
 闡能科技股份有限公司

Major Customer

(Taiwan / Korea / Japan / Canada)

Getac

神基科技股份有限公司

HUMAX

www.humaxdigital.com



科技股份有限公司



泰金寶電通

DynaPack

順達科技股份有限公司
 www.dynapack.com.tw



www.memoryexpertsinc.com



合世生醫科技股份有限公司



雙揚科技股份有限公司

Raritan.

荷蘭商瑞力登國際有限公司



www.spinmaster.com



APack

典暉科技股份有限公司



德立斯科技股份有限公司



鉅瞻科技股份有限公司



環天世通科技股份有限公司



群利科技股份有限公司



巨輪興業股份有限公司



陞泰科技股份有限公司



Alfa-MOS Technology Corp.
 闡能科技股份有限公司

Major Customer

(China)



華盛玩具有限公司
 WAH SHING TOYS CO., LTD.



冠德科技(北海)有限公司



深圳市高普达科技有限公司

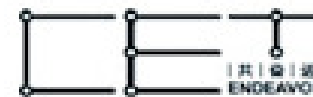

深圳市共奋进有限公司



深圳朗特智能控制股份有限公司



新迪精密科技有限公司

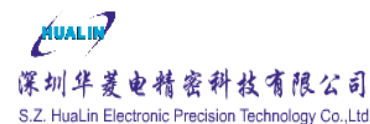

深圳华菱电精密科技有限公司
 S.Z. HuaLin Electronic Precision Technology Co.,Ltd.



深圳市群智信息技术有限公司



惠州市蓝微电子有限公司



深圳市诚信诺科技有限公司



苏州和钧新能源有限公司



伊戈尔电气股份有限公司



杭特電子股份有限公司



广州贵冠科技有限公司



深圳市愛圖仕影像器材有限公司



深圳市博源电子有限公司



深圳市德晟鑫科技有限公司



香港Favour Light



廈門頂尖電子有限公司



深圳市興龍輝科技有限公司



深圳市韵涛通信技术有限公司



西西艾设计制造有限公司



宁波兴华电子有限公司